

Shin-Long

SPECIFICATION

Aluminate - LED Panel Light



Product Details



Application

- Office
- University/School
- Show room
- Library
- Hospital
- Exhibition Hall
- Supermarket

Features

- Ultra-thin 10mm
- Instant on/off, no noise/UV/light leak/shadow
- CE, RoHS, ERP certified
- Material: AL + PMMA
- IK06, IP40
- Global patent protection led source, projected lifespan>100,000hrs
- TUV/ENEC listed driver, flicker free
- 100lm/w, 130lm/w optional
- Available in non-dimming, 0~10V / Triac / DALI / CCT dimming, emergency versions
- L80B50 Lifespan(Ta=25°C): 70,000hrs
- SDCM<4
- 5 years warranty

Temperature

Operating: -20 ~ +50°C



Product Details



Dimensions

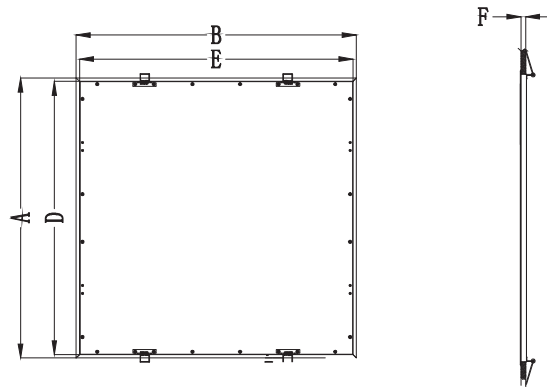

Cut-out Size(D*E)	Frame Size(A*B)	Thickness(F)
295x295mm	307x307mm	10mm
295x1195mm	307x1207mm	10mm
595x595mm	607x607mm	10mm
620x620mm	632x632mm	10mm
595x1195mm	607x1207mm	10mm

Data Sheet

Article Number	Size	Power	LEDs	Beam Angle	CRI	AC Input	DC Output	SDCM	Efficiency (±5%)	Lumen Output
Standard Lumen Version										
NSA-12-12W	295*295mm	12W	78	120°	>80	200~240V	30~40V	<4	90lm/w	1000~1100lm
NSA-12-25W	295*295mm	25W	78	120°	>80	200~240V	30~40V	<4	90lm/w	2100~2400lm
NSA-12-40W	295*1195mm	40W	260	120°	>80	200~240V	30~40V	<4	100lm/w	3800~4200lm
NSA-24XL-40W	595*595mm	40W	156	120°	>80	200~240V	30~40V	<4	100lm/w	3800~4200lm
NSA-24-50W	595*595mm	50W	208	120°	>80	200~240V	30~40V	<4	100lm/w	4750~5250lm
NSA-24XL-40W	620*620mm	40W	156	120°	>80	200~240V	30~40V	<4	100lm/w	3800~4200lm
NSA-24XL-50W-PL	620*620mm	50W	208	120°	>80	200~240V	30~40V	<4	100lm/w	4750~5250lm
NSA-24-60W	595*1195mm	60W	312	120°	>80	200~240V	30~40V	<4	100lm/w	5700~6300lm
Premium Lumen Version										
NSA-12-40W-PL	295*1195mm	40W	364	120°	>80	200~240V	30~40V	<4	130lm/w	5000~5400lm
NSA-24XL-40W-PL	595*595mm	40W	208	120°	>80	200~240V	30~40V	<4	130lm/w	5000~5400lm
NSA-24-50W-PL	595*595mm	50W	260	120°	>80	200~240V	30~40V	<4	130lm/w	6250~6750lm
NSA-24XL-40W-PL	620*620mm	40W	208	120°	>80	200~240V	30~40V	<4	130lm/w	5000~5400lm
NSA-24XL-50W-PL	620*620mm	50W	260	120°	>80	200~240V	30~40V	<4	130lm/w	6250~6750lm
NSA-24-60W-PL	595*1195mm	60W	364	120°	>80	200~240V	30~40V	<4	130lm/w	7500~8100lm

Different wattage can be customized

Flexibility



Male and female connectors

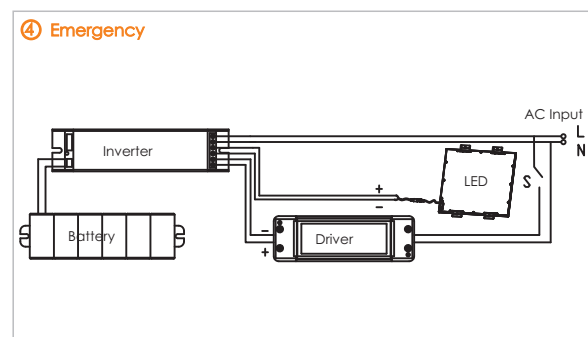
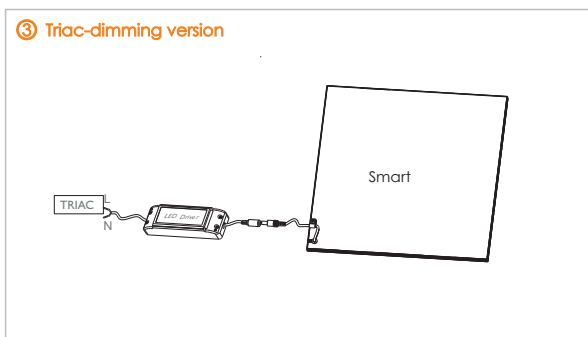
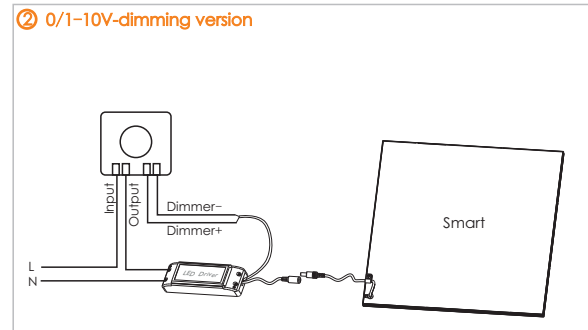
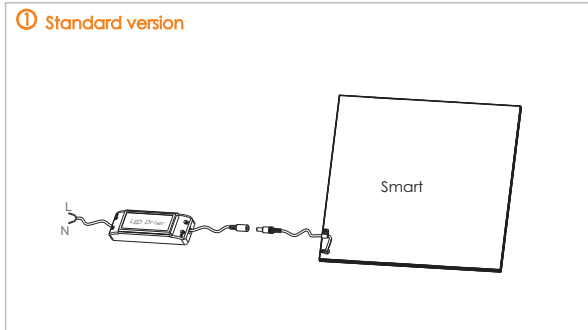

Recessed Installation

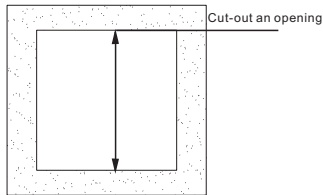
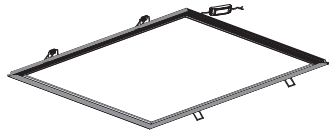

Frame Size	Cut Out Size
307x307mm	295x295mm
307x1207mm	295x1195mm
607x607mm	595x595mm
632x632mm	620x620mm
607x1207mm	595x1195mm

Step 1

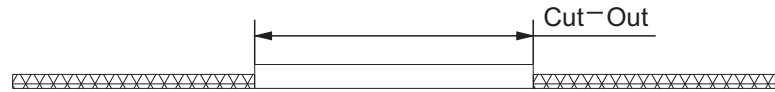

Cutting same opening as the panel lamp at the corresponding mounted position.

Step 2



Connecting the power cables.

Step 3



Fixing the spring buckle into the existing opening.

Step 4



Loosen the spring buckle off and adjust position of panel accordingly.

Package

Item code	Size	Carton Size	N.W./CTN	G.W./CTN	Maximum Loading of		
					20'GP	40'GP	40'HQ
NSA-12-12W / NSA-12-25W	295*295*10mm	375X260X375mm	9.5kg	11.5kg	401CTNs	720CTNs	761CTNs
NSA-24-40W / NSA-24-50W	595*595*10mm	675X260X675mm	19kg	22.5kg	249CTNs	510CTNs	561CTNs
NSA-24XL-40W / NSA-24XL-50W	620*620*10mm	700X260X700mm	20kg	23.5kg	228CTNs	472CTNs	540CTNs
NSA-12-40W	295*1195*10mm	1275X260X375mm	18.5kg	22kg	132CTNs	274CTNs	312CTNs
NSA-24-60W	595*1195*10mm	1275X260X675mm	37kg	42kg	121CTNs	247CTNs	288CTNs

